

LMV321

General Purpose, Rail-to-Rail Output Amplifier

Rail-to-Rail Amplifiers



FEATURES

- 130 μ A supply current
- 1MHz gain bandwidth
- Input voltage range with 5V supply: -0.2V to 4.2V
- Output voltage range with 5V supply: 0.065V to 4.99V
- >1V/ μ s slew rate
- No crossover distortion
- Fully specified at 2.7V and 5V supplies
- LMV321: Pb-free TSOT-5

APPLICATIONS

- Portable/battery-powered applications
- Mobile communications, cell phones, pagers
- ADC buffer
- Active filters
- Portable test instruments
- Signal conditioning
- Medical Equipment
- Portable medical instrumentation

General Description

The LMV321 is a single channel, low cost, voltage feedback amplifier. The LMV321 consumes only 130 μ A of supply current and is designed to operate from a supply range of 2.7V to 5.5V (± 1.35 to ± 2.75). The input voltage range extends 200mV below the negative rail and 800mV below the positive rail.

The LMV321 is fabricated on a CMOS process. It offers 1MHz gain bandwidth product and >1V/ μ s slew rate. The combination of low power, low supply voltage operation, and rail-to-rail performance make the LMV321 well suited for battery-powered systems. The LMV321 is packaged in the space saving TSOT-5 package. TSOT-5 package is pin compatible with the SOT23-5 package.

Typical Performance Examples

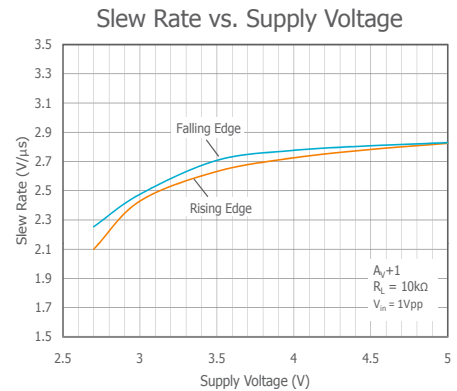
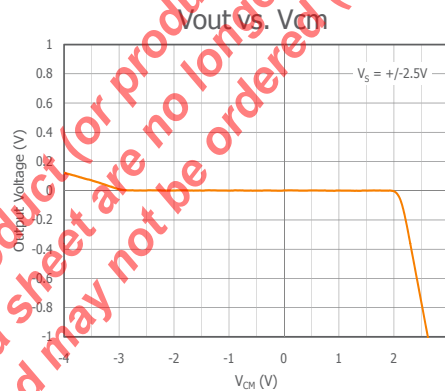

Ordering Information

Part Number	Package	Pb-Free	RoHS Compliant	Operating Temperature Range	Packaging Method
LMV321IST5X	TSOT-5	Yes	Yes	-40°C to +85°C	Reel

Moisture sensitivity level for all parts is MSL-1.

The product (or products) mentioned in this data sheet are no longer being manufactured and may not be ordered (OBS)

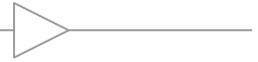

LMV321 Pin Configuration

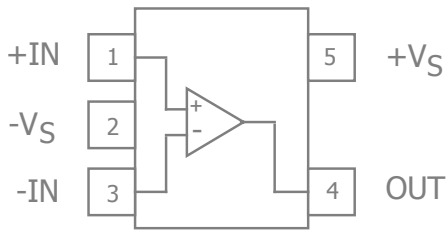

LMV321 Pin Assignments¹

Pin No.	Pin Name	Description
1	+IN	Positive input
2	-Vs	Negative supply
3	-IN	Negative input
4	OUT	Output
5	+Vs	Positive supply

Notes:

1.Pin compatible to SOT23-5.

The product (or products) mentioned in this data sheet are no longer being manufactured and may not be ordered (OBS)



Absolute Maximum Ratings

The safety of the device is not guaranteed when it is operated above the "Absolute Maximum Ratings". The device should not be operated at these "absolute" limits. Adhere to the "Recommended Operating Conditions" for proper device function. The information contained in the Electrical Characteristics tables and Typical Performance plots reflect the operating conditions noted on the tables and plots.

Parameter	Min	Max	Unit
Supply Voltage		7	V
Input Voltage Range	$-V_S - 0.4V$	$+V_S$	V
Continuous Output Current	Output is protected against momentary short circuit		

Reliability Information

Parameter	Min	Typ	Max	Unit
Junction Temperature			150	°C
Storage Temperature Range	-65		150	°C
Lead Temperature (Soldering, 10s)			260	°C
Package Thermal Resistance				
5-Lead TSOT		221		°C/W

Notes:

Package thermal resistance (θ_{JA}), JEDEC standard, multi-layer test boards, still air.

ESD Protection

Product	TSOT-5
Human Body Model (HBM)	2kV
Charged Device Model (CDM)	2kV

Recommended Operating Conditions

Parameter	Min	Typ	Max	Unit
Operating Temperature Range	-40		+85	°C
Supply Voltage Range	2.7		5.5	V

The product (or products) mentioned in this data sheet are no longer being manufactured and may not be ordered (OBS)



Electrical Characteristics at +2.7V

$T_A = 25^\circ\text{C}$, $V_S = +2.7\text{V}$, $R_f = R_g = 10\text{ k}\Omega$, $R_L = 10\text{ k}\Omega$ to $V_S/2$, $G = 2$; unless otherwise noted.

Symbol	Parameter	Conditions	Min	Typ	Max	Units
DC Performance						
V_{IO}	Input Offset Voltage			1.7	7	mV
dV_{IO}	Average Drift			5		$\mu\text{V}/^\circ\text{C}$
I_b	Input Bias Current			<1	250	nA
I_{OS}	Input Offset Current			<1	50	nA
CMRR	Common Mode Rejection Ratio	$0\text{V} \leq V_{CM} \leq 1.7\text{V}$	50	63		dB
PSRR	Power Supply Rejection Ratio	$2.7\text{V} \leq V^+ \leq 5\text{V}$, $V_O=1\text{V}$, $V_{CM}=1\text{V}$	50	60		dB
CMIR	Common Mode Input Range	For $V_{CM} \leq 50\text{ dB}$	0	-0.2		V
				1.9	1.7	V
V_{OUT}	Output Voltage Swing	$R_L = 10\text{ k}\Omega$ to $V_S/2$	$V^+ - 100$	$V^+ - 10$		mV
				60	180	mV
I_S	Supply Current			110	170	μA
AC Performance						
GBWP	Gain Bandwidth Product	$C_L = 200\text{ pF}$		1		MHz
Φ_m	Phase Margin			60		$^\circ$
G_m	Gain Margin			10		dB
e_n	Input Voltage Noise	$f = 1\text{ kHz}$		46		$\text{nV}/\sqrt{\text{Hz}}$

Notes:

Min max specifications are guaranteed by testing, design, or characterization

The product (or products) mentioned in this data sheet are no longer being manufactured and may not be ordered (OBS)



Electrical Characteristics at +5V

$T_A = 25^\circ\text{C}$, $V_S = +5\text{V}$, $R_f = R_g = 10\text{k}\Omega$, $R_L = 10\text{k}\Omega$ to $V_S/2$, $G = 2$; unless otherwise noted. **Boldface** limits apply at the temperature extremes.

Symbol	Parameter	Conditions	Min	Typ	Max	Units
DC Performance						
V_{IO}	Input Offset Voltage			1.7	7 9	mV
dV_{IO}	Average Drift			5		$\mu\text{V}/^\circ\text{C}$
I_b	Input Bias Current			<1	250 500	nA
I_{OS}	Input Offset Current			<1	50 150	nA
CMRR	Common Mode Rejection Ratio	$0\text{V} \leq V_{CM} \leq 4\text{V}$	50	65		dB
PSRR	Power Supply Rejection Ratio	$2.7\text{V} \leq V^+ \leq 5\text{V}$, $V_O=1\text{V}$, $V_{CM}=1\text{V}$	50	60		dB
CMIR	Common Mode Input Range	For $V_{CM} \leq 50$ dB	0	-0.2		V
				4.2	4	V
A_{OL}	Open-Loop Gain	$R_L = 2\text{k}\Omega$	15 10	100		V/mV
V_{OUT}	Output Voltage Swing	$R_L = 2\text{k}\Omega$ to $V_S/2$	$V^+ - 300$ $V^+ - 400$	$V^+ - 40$		mV
				120	300 400	mV
		$R_L = 10\text{k}\Omega$ to $V_S/2$	$V^+ - 100$ $V^+ - 200$	$V^+ - 10$		mV
				65	180 280	mV
I_{SC}	Short Circuit Output Current	Sourcing $V_O=0\text{V}$	5	60		mA
		Sinking $V_O=-5\text{V}$	10	160		mA
I_S	Supply Current			130	250 350	μA
AC Performance						
SR	Slew Rate			>1		V/ μs
GBWP	Gain Bandwidth Product	$C \leq 200$ pF		1		MHz
Φ_m	Phase Margin			60		$^\circ$
G_m	Gain Margin			10		dB
e_n	Input Voltage Noise	$f = 1\text{kHz}$		39		nV/ $\sqrt{\text{Hz}}$

Notes:

Min max specifications are guaranteed by testing, design, or characterization



Typical Performance Characteristics at +5V - Continued

$T_A = 25^\circ\text{C}$, $V_S = +5\text{V}$, $R_f = R_g = 10\text{k}\Omega$, $R_L = 10\text{k}\Omega$ to $V_S/2$, $G = 2$; unless otherwise noted.

LMV321 General Purpose, Rail-to-Rail Output Amplifier Rev 1A

V_{IO} vs. CMR +2.7V

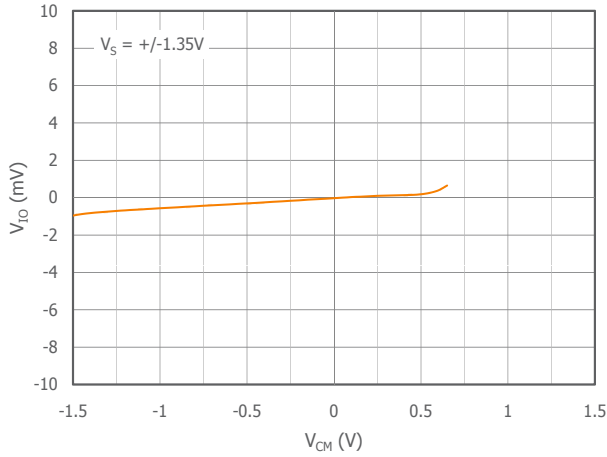

V_{IO} vs. CMR +5V

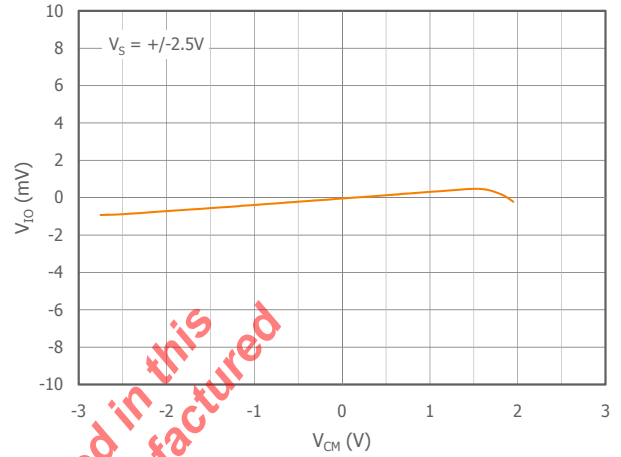

V_{OUT} vs. V_{CM} +2.7V

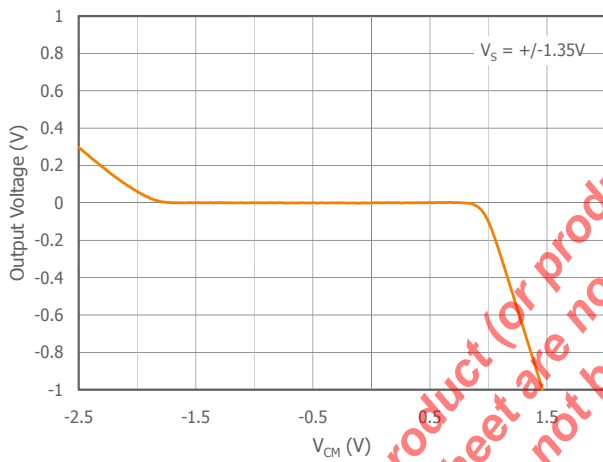

V_{OUT} vs. V_{CM} +5V

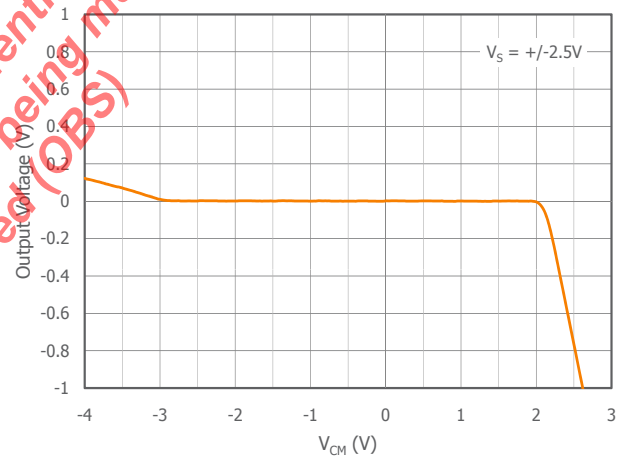

Supply Current vs. Supply Voltage

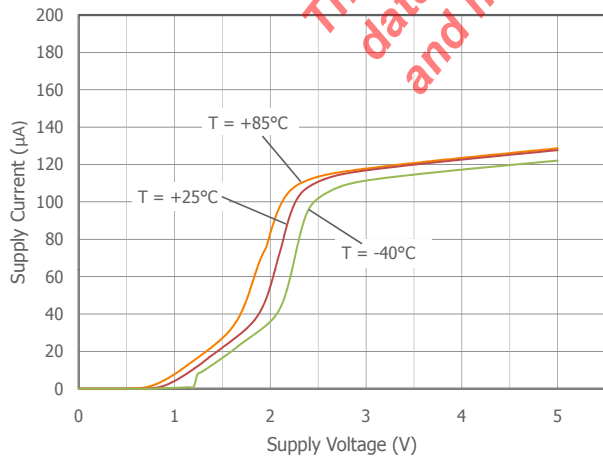

Input Current vs. Temperature

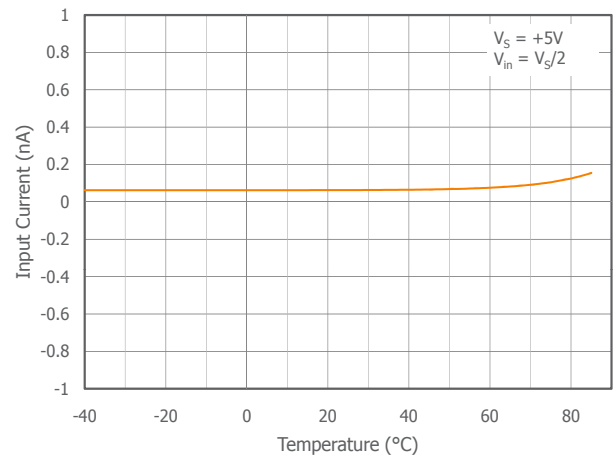

The product (or products) mentioned in this data sheet are no longer being manufactured and may not be ordered (OBS)



Typical Performance Characteristics at +5V - Continued

$T_A = 25^\circ\text{C}$, $V_S = +5\text{V}$, $R_f = R_g = 10\text{k}\Omega$, $R_L = 10\text{k}\Omega$ to $V_S/2$, $G = 2$; unless otherwise noted.

Sinking Current vs. Output Voltage +2.7V

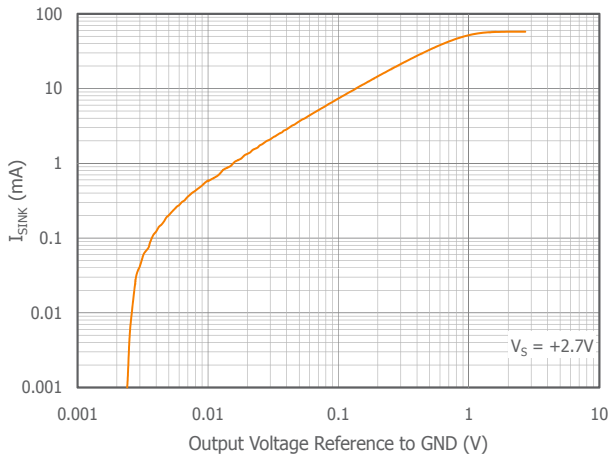

Sinking Current vs. Output Voltage +5V

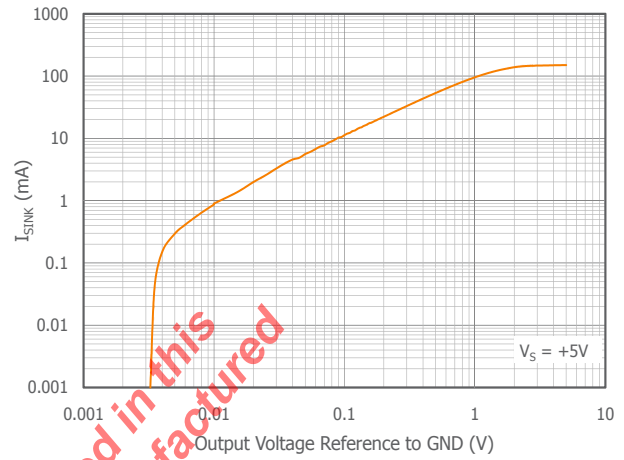

Sourcing Current vs. Output Voltage +2.7V

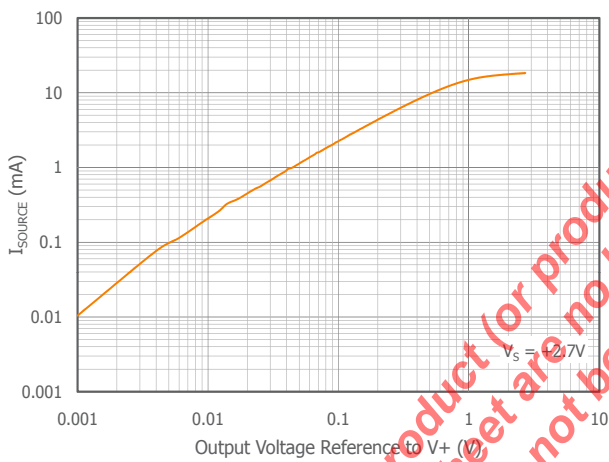

Sourcing Current vs. Output Voltage +5V

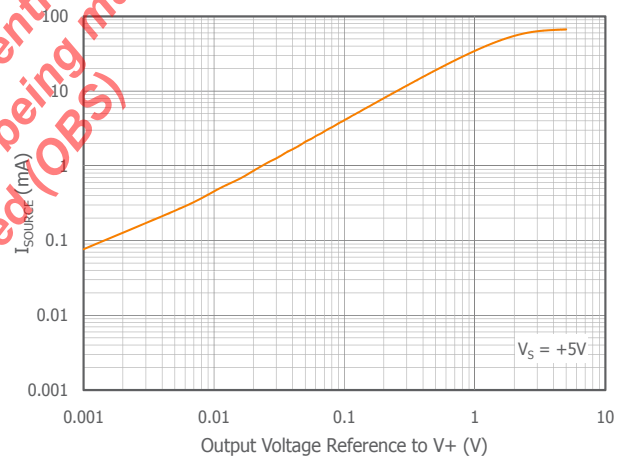

Short Circuit Current vs. Temperature (Sinking)

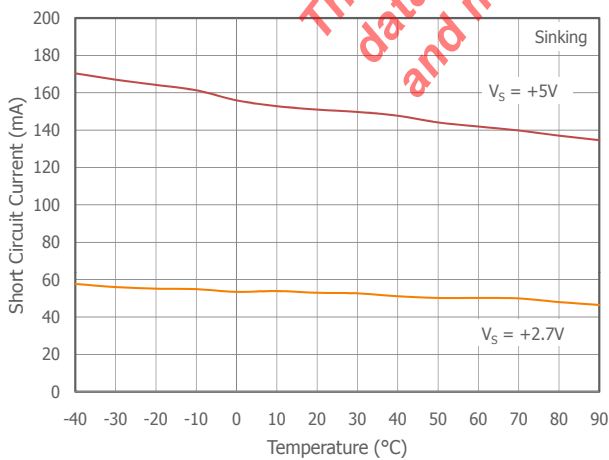

Short Circuit Current vs. Temperature (Sourcing)

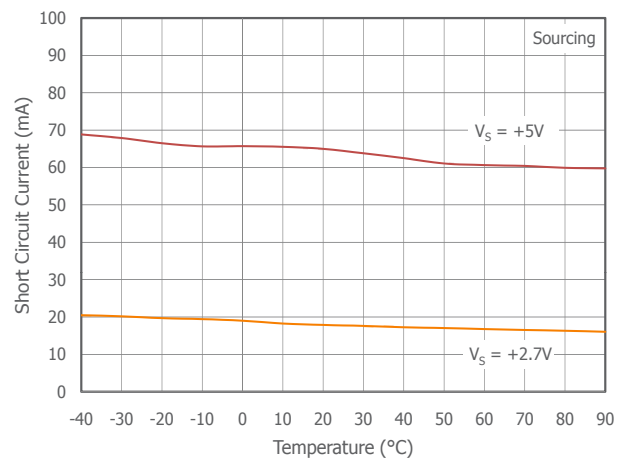

The product (or products) mentioned in this data sheet are no longer being manufactured and may not be ordered (OBS)

LMV321 General Purpose, Rail-to-Rail Output Amplifier Rev. 1A



Typical Performance Characteristics at +5V - Continued

$T_A = 25^\circ\text{C}$, $V_S = +5\text{V}$, $R_f = R_g = 10\text{k}\Omega$, $R_L = 10\text{k}\Omega$ to $V_S/2$, $G = 2$; unless otherwise noted.

Output Voltage Swing vs. Supply Voltage

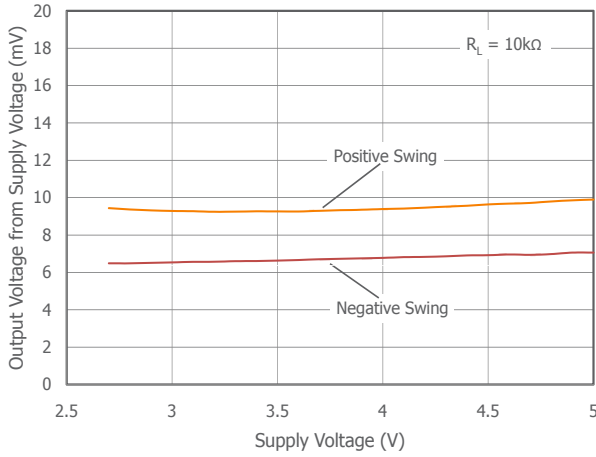

Slew Rate vs. Supply Voltage

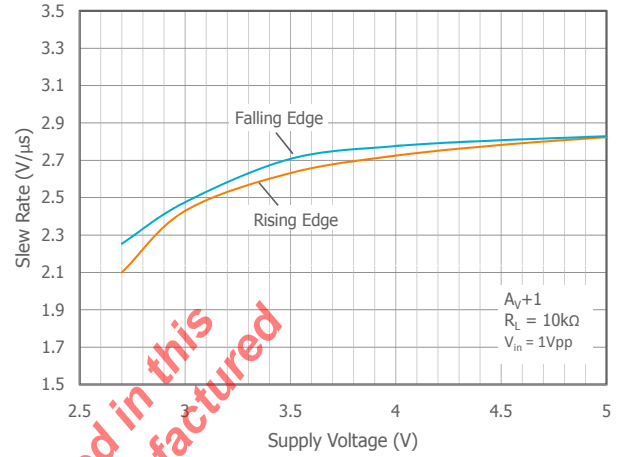

CMRR vs. Frequency

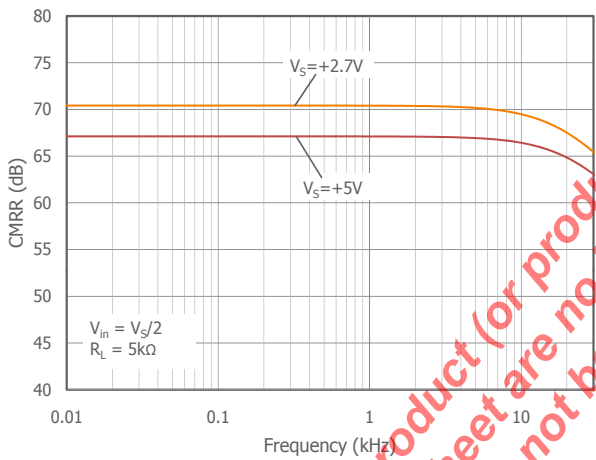

PSRR vs. Frequency

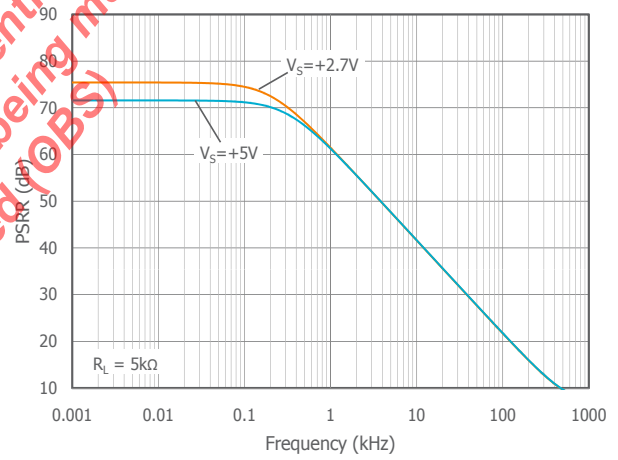

Input Voltage Noise vs. Frequency

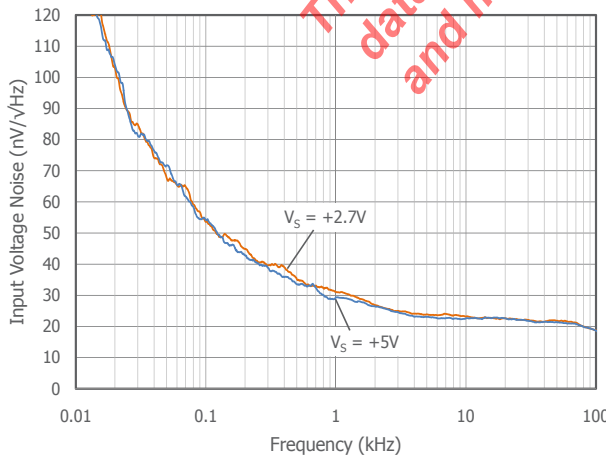

THD vs. Frequency

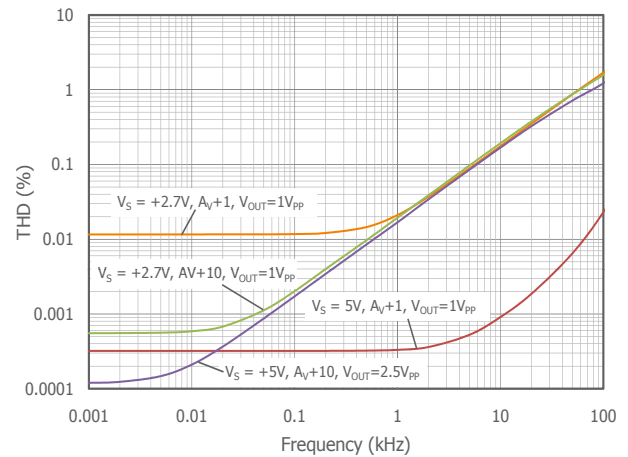

The product (or products) mentioned in this data sheet are no longer being manufactured and may not be ordered (BSS)

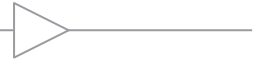

Typical Performance Characteristics at +5V - Continued

$T_A = 25^\circ\text{C}$, $V_S = +5\text{V}$, $R_f = R_g = 10\text{k}\Omega$, $R_L = 10\text{k}\Omega$ to $V_S/2$, $G = 2$; unless otherwise noted.

Open Loop Output Impedance vs. Frequency

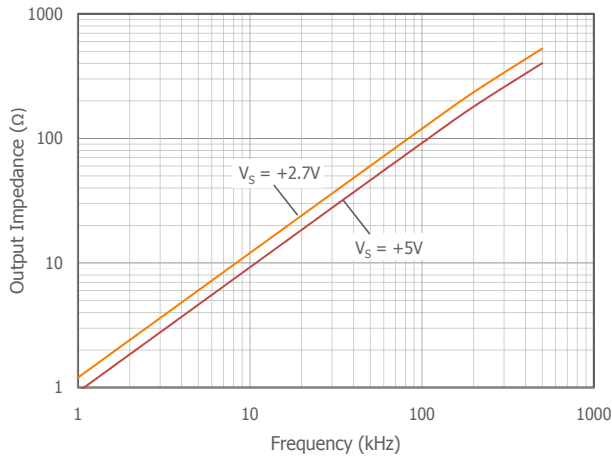

Open Loop Frequency Response +2.7V

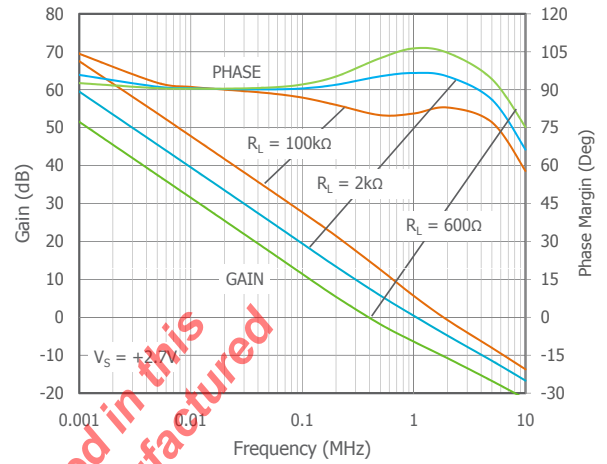

Open Loop Frequency Response 5V

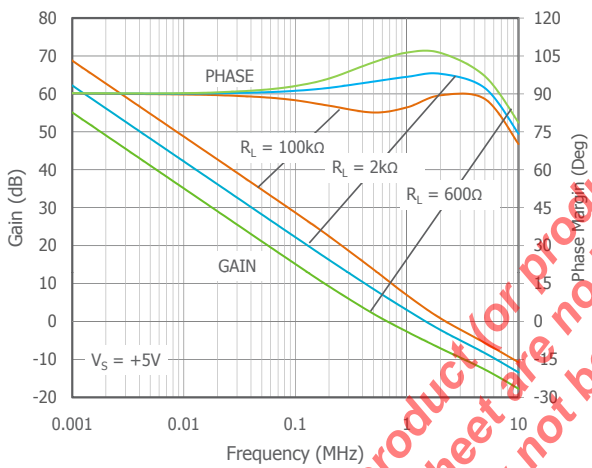

Open Loop Frequency Response vs. Temperature

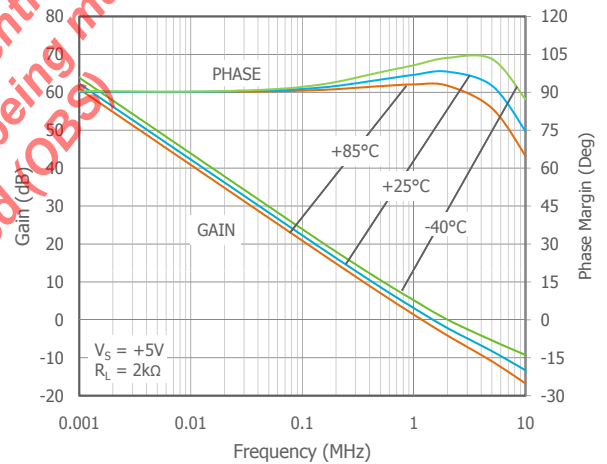

Gain and Phase vs. Capacitive Load $R_L = 600\Omega$

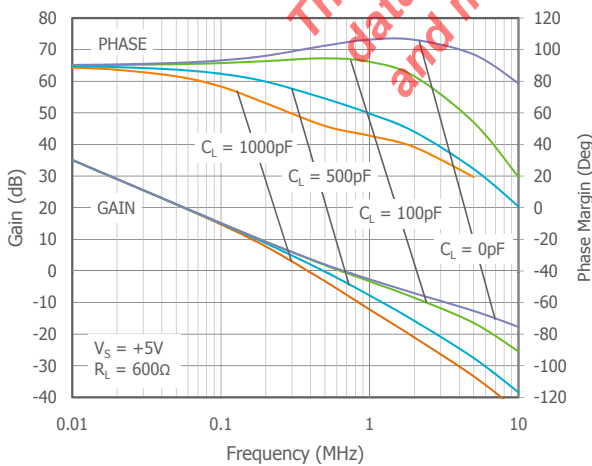

Gain and Phase vs. Capacitive Load $R_L = 100\text{k}\Omega$

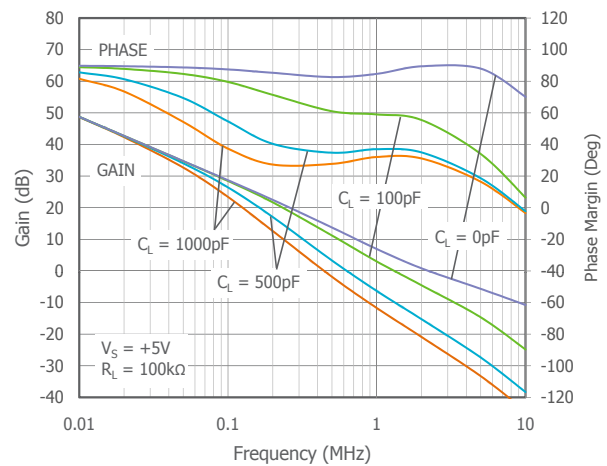

LMV321 General Purpose, Rail-to-Rail Output Amplifier Rev. 1A

The product (or products) mentioned in this data sheet are no longer being manufactured and may not be ordered (OBSO)



Typical Performance Characteristics at +5V - Continued

$T_A = 25^\circ\text{C}$, $V_S = +5\text{V}$, $R_f = R_g = 10\text{k}\Omega$, $R_L = 10\text{k}\Omega$ to $V_S/2$, $G = 2$; unless otherwise noted.

Inverting Large Signal Pulse Response

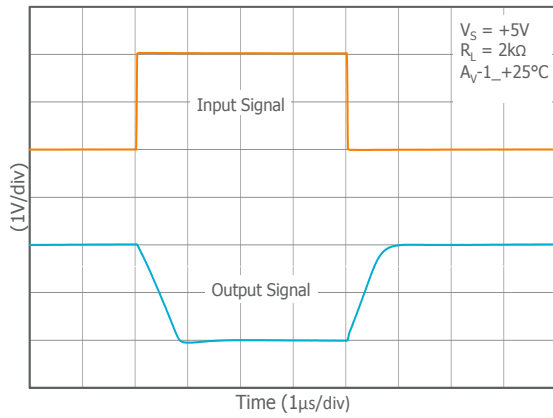

Inverting Large Signal Pulse Response

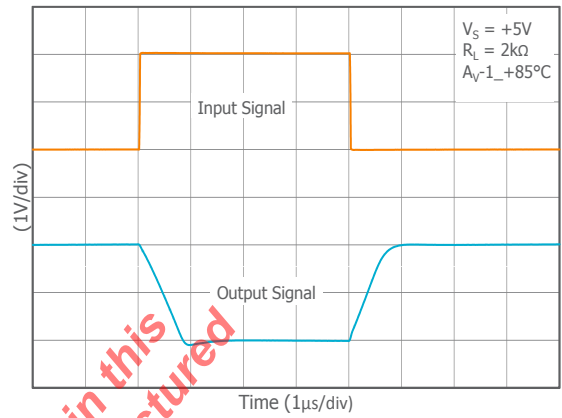

Inverting Large Signal Pulse Response

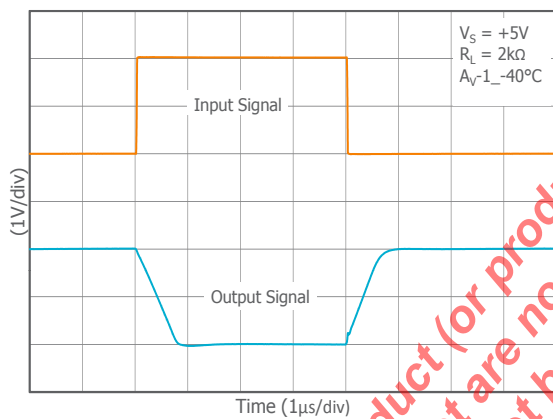

Inverting Small Signal Pulse Response

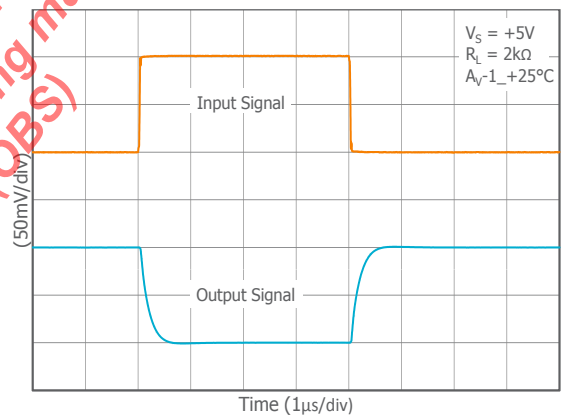

Inverting Small Signal Pulse Response

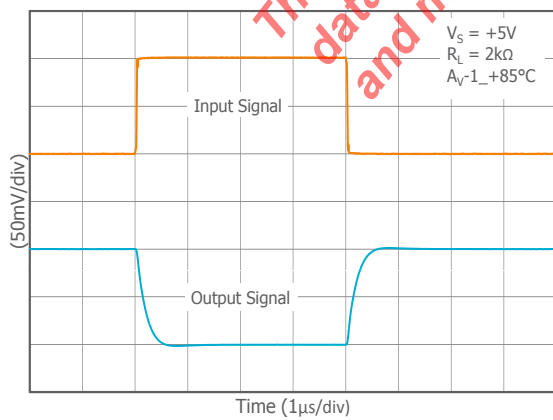

Inverting Small Signal Pulse Response

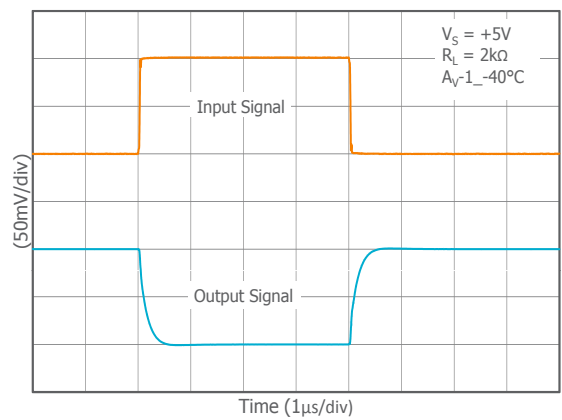

The product (or products) mentioned in this data sheet are no longer being manufactured and may not be ordered (OBS)



Typical Performance Characteristics at +5V - Continued

$T_A = 25^\circ\text{C}$, $V_S = +5\text{V}$, $R_f = R_g = 10\text{k}\Omega$, $R_L = 10\text{k}\Omega$ to $V_S/2$, $G = 2$; unless otherwise noted.

Non-Inverting Large Signal Pulse Response

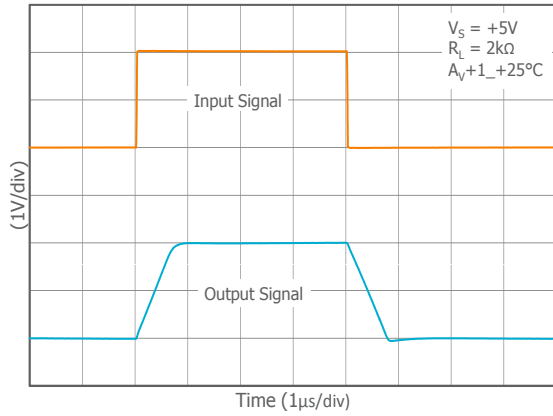

Non-Inverting Large Signal Pulse Response

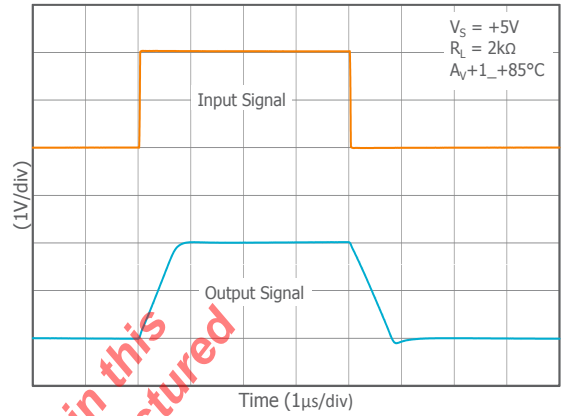

Non-Inverting Large Signal Pulse Response

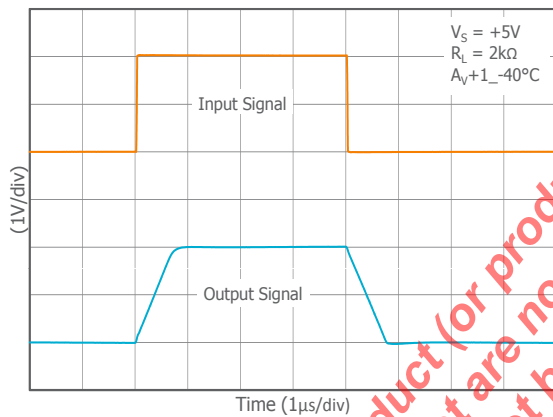

Non-Inverting Small Signal Pulse Response

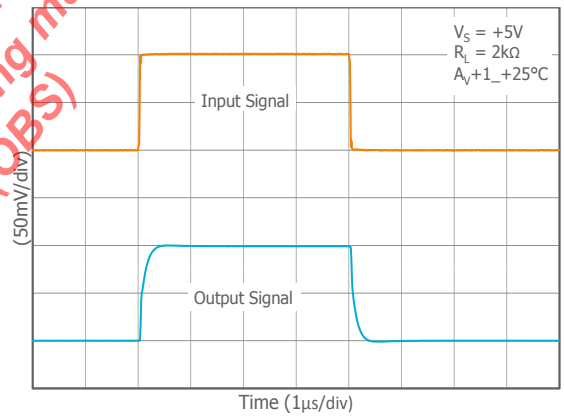

Non-Inverting Small Signal Pulse Response

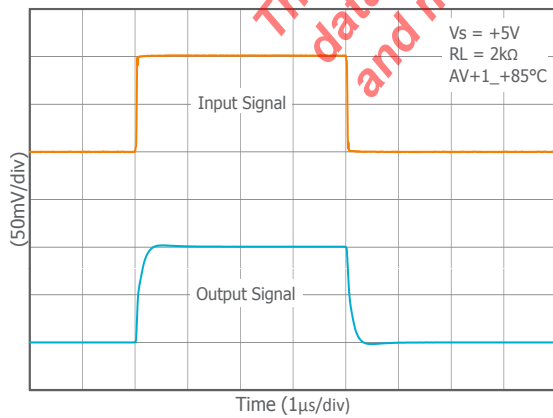

Non-Inverting Small Signal Pulse Response

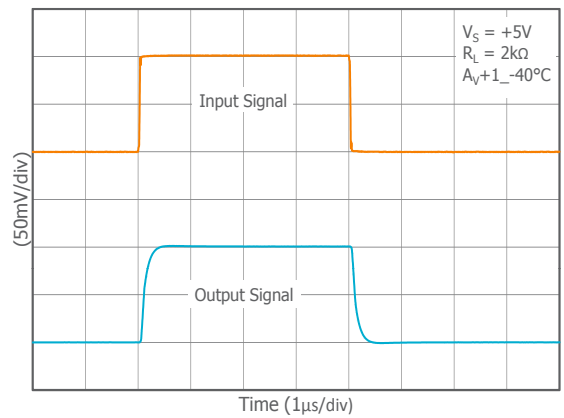

The product (or products) mentioned in this data sheet are no longer being manufactured and may not be ordered (OBS)



Application Information

General Description

The LMV321 is a single supply, general purpose, voltage-feedback amplifier fabricated on a CMOS process. The LMV321 offers 1MHz gain bandwidth product, >1V/μs slew rate, and only 130μA supply current. It features a rail-to-rail output stage and is unity gain stable.

The common mode input range extends to 200mV below ground and to 800mV below Vs. Exceeding these values will not cause phase reversal. However, if the input voltage exceeds the rails by more than 0.5V, the input ESD devices will begin to conduct. The output will stay at the rail during this overdrive condition.

The output stage is short circuit protected and offers "soft" saturation protection that improves recovery time. Figures 1, 2, and 3 illustrate typical circuit configurations for non-inverting, inverting, and unity gain topologies for dual supply applications. They show the recommended bypass capacitor values and overall closed loop gain equations. Figure 4 shows the typical non-inverting gain circuit for single supply applications

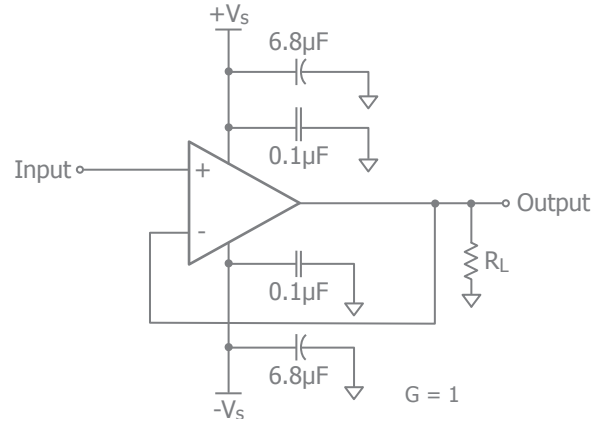

Figure 3. Unity Gain Circuit

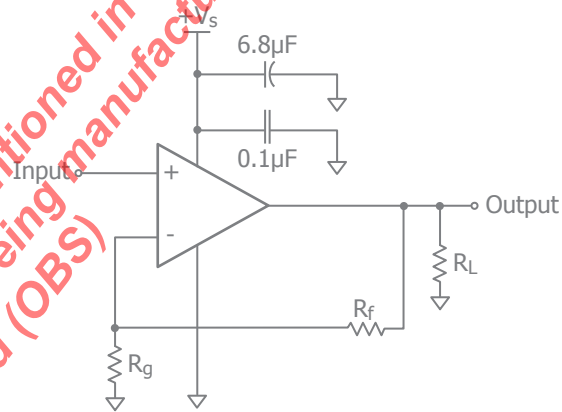

Figure 4. Single Supply Non-Inverting Gain Circuit

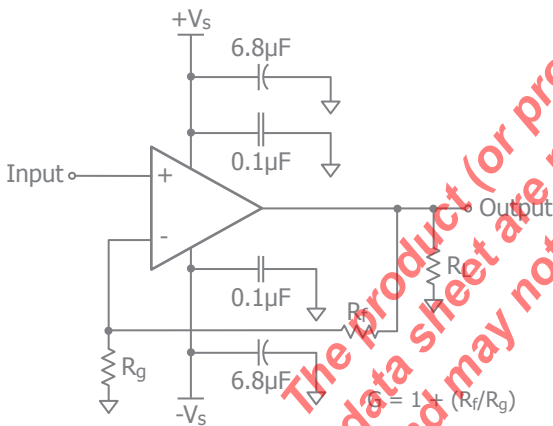

Figure 1. Typical Non-Inverting Gain Circuit

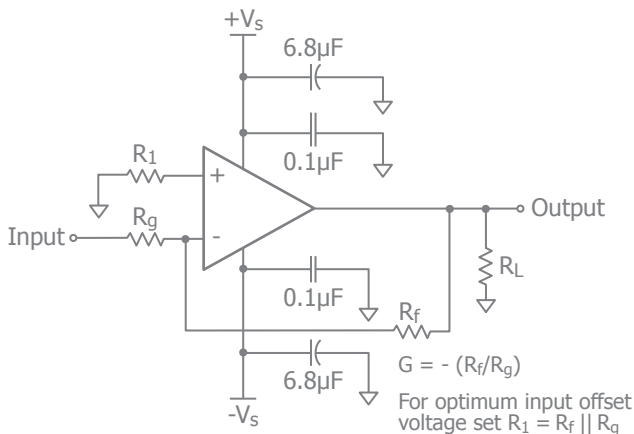

Figure 2. Typical Inverting Gain Circuit

Power Dissipation

Power dissipation should not be a factor when operating under the stated 2kΩ load condition. However, applications with low impedance, DC coupled loads should be analyzed to ensure that maximum allowed junction temperature is not exceeded. Guidelines listed below can be used to verify that the particular application will not cause the device to operate beyond its intended operating range.

Maximum power levels are set by the absolute maximum junction rating of 150°C. To calculate the junction temperature, the package thermal resistance value Θ_{JA} (Θ_{JA}) is used along with the total die power dissipation.

$$T_{\text{Junction}} = T_{\text{Ambient}} + (\Theta_{JA} \times P_D)$$

Where T_{Ambient} is the temperature of the working environment.

In order to determine P_D , the power dissipated in the load needs to be subtracted from the total power delivered by



the supplies.

$$P_D = P_{\text{supply}} - P_{\text{load}}$$

Supply power is calculated by the standard power equation.

$$P_{\text{supply}} = V_{\text{supply}} \times I_{\text{RMS supply}}$$

$$V_{\text{supply}} = V_{S+} - V_{S-}$$

Power delivered to a purely resistive load is:

$$P_{\text{load}} = ((V_{\text{LOAD}})_{\text{RMS}})^2 / R_{\text{load eff}}$$

The effective load resistor ($R_{\text{load eff}}$) will need to include the effect of the feedback network. For instance,

$R_{\text{load eff}}$ in Figure 3 would be calculated as:

$$R_L \parallel (R_f + R_g)$$

These measurements are basic and are relatively easy to perform with standard lab equipment. For design purposes however, prior knowledge of actual signal levels and load impedance is needed to determine the dissipated power. Here, P_D can be found from

$$P_D = P_{\text{Quiescent}} + P_{\text{Dynamic}} - P_{\text{Load}}$$

Quiescent power can be derived from the specified I_S values along with known supply voltage, V_{Supply} . Load power can be calculated as above with the desired signal amplitudes using:

$$(V_{\text{LOAD}})_{\text{RMS}} = V_{\text{PEAK}} / \sqrt{2}$$

$$(I_{\text{LOAD}})_{\text{RMS}} = (V_{\text{LOAD}})_{\text{RMS}} / R_{\text{load eff}}$$

The dynamic power is focused primarily within the output stage driving the load. This value can be calculated as:

$$P_{\text{DYNAMIC}} = (V_{S+} - V_{\text{LOAD}})_{\text{RMS}} \times (I_{\text{LOAD}})_{\text{RMS}}$$

Assuming the load is referenced in the middle of the power rails or $V_{\text{supply}}/2$.

The LMV321 is short circuit protected. However, this may not guarantee that the maximum junction temperature (+150°C) is not exceeded under all conditions.

Driving Capacitive Loads

Increased phase delay at the output due to capacitive loading can cause ringing, peaking in the frequency response, and possible unstable behavior. Use a series resistance, R_S , between the amplifier and the load to help improve stability and settling performance. Refer to Figure 5.

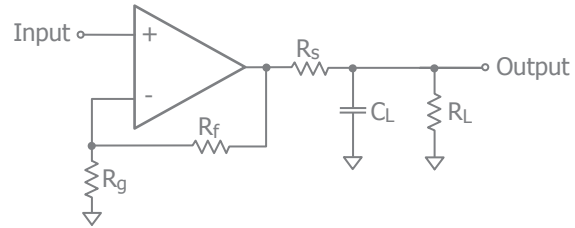

Figure 5. Addition of R_S for Driving Capacitive Loads

For a given load capacitance, adjust R_S to optimize the tradeoff between settling time and bandwidth. In general, reducing R_S will increase bandwidth at the expense of additional overshoot and ringing.

Overdrive Recovery

An overdrive condition is defined as the point when either one of the inputs or the output exceed their specified voltage range. Overdrive recovery is the time needed for the amplifier to return to its normal or linear operating point. The recovery time varies, based on whether the input or output is overdriven and by how much the range is exceeded. The LMV321 will typically recover in less than 5 μ s from an overdrive condition. Figure 6 shows the LMV321 in an overdriven condition.

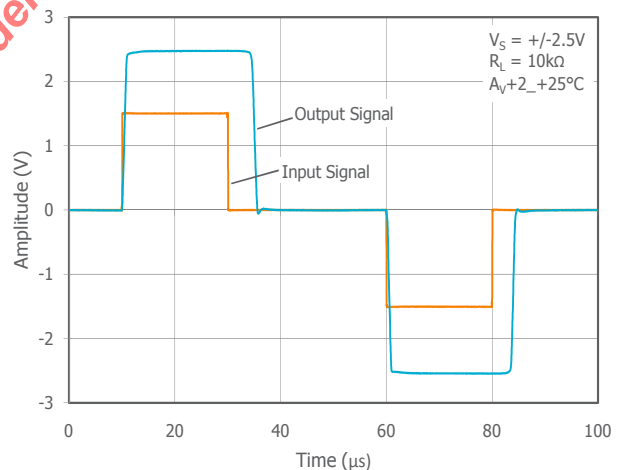
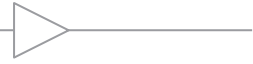

Figure 6. Overdrive Recovery

Layout Considerations

General layout and supply bypassing play major roles in high frequency performance. CADEKA has evaluation boards to use as a guide for high frequency layout and as an aid in device testing and characterization. Follow the steps below as a basis for high frequency layout:

- Include 6.8 μ F and 0.1 μ F ceramic capacitors for power



supply decoupling

- Place the 6.8 μ F capacitor within 0.75 inches of the power pin
- Place the 0.1 μ F capacitor within 0.1 inches of the power pin
- Remove the ground plane under and around the part, especially near the input and output pins to reduce parasitic capacitance
- Minimize all trace lengths to reduce series inductances

Evaluation Board Schematics

Evaluation board schematics and layouts are shown in Figures 7-9. These evaluation boards are built for dual supply operation. Follow these steps to use the board in a single-supply application:

- Short -Vs to ground.
- Use C3 (6.8 μ F) and C4 (0.1 μ F), if the -Vs pin of the amplifier is not directly connected to the ground plane.

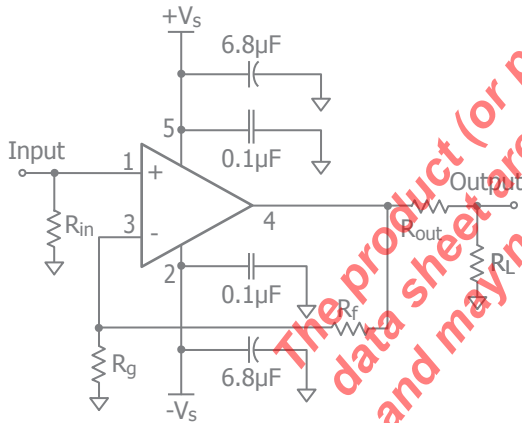

Figure 7. CEB004 Schematic

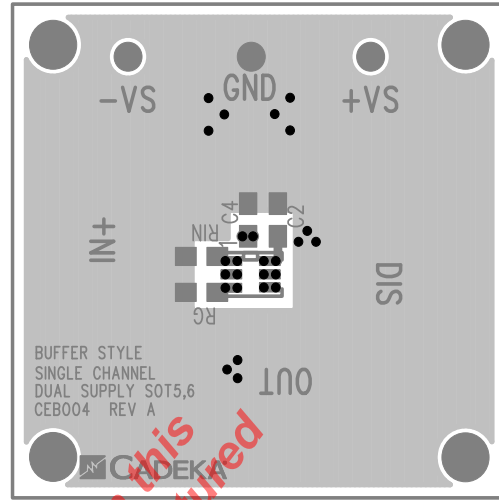

Figure 8. CEB004 Top View

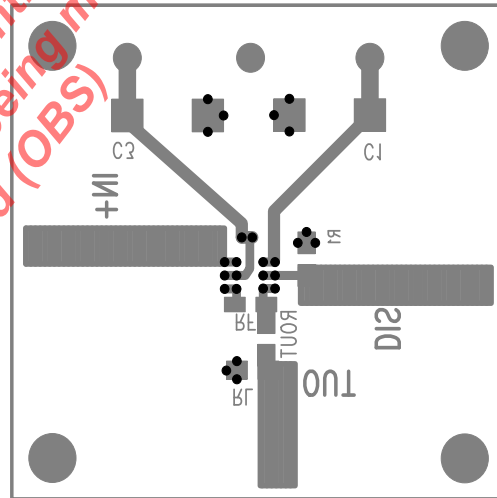
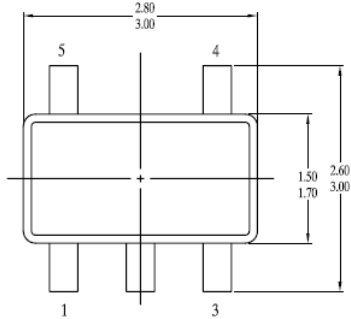

Figure 9. CEB004 Bottom View



Mechanical Dimensions

TSOT-5 Package



TOP VIEW

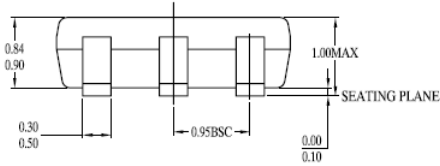

FRONT VIEW

NOTE:

1. ALL DIMENSIONS ARE IN MILLIMETERS.
2. PACKAGE LENGTH DOES NOT INCLUDE INTERLEAD FLASH OR PROTRUSION.
3. PACKAGE WIDTH DOES NOT INCLUDE INTERLEAD FLASH OR PROTRUSION.
4. LEAD COPLANARITY (BOTTOM OF LEADS AFTER FORMING) SHALL BE 0.10 MILLIMETERS MAX.
5. DRAWING CONFORMS TO JEDEC MO-193, VARIATION AA.
6. DRAWING IS NOT TO SCALE.

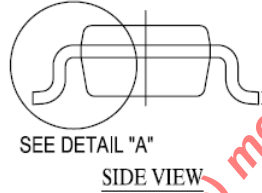

SIDE VIEW

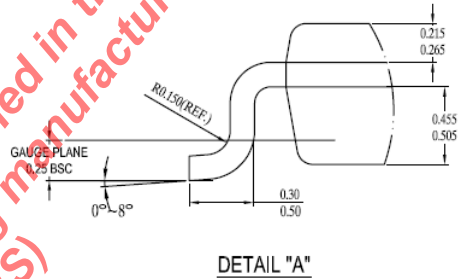

DETAIL "A"

The product (or products) mentioned in this data sheet are no longer being manufactured and may not be ordered (OBS)

For Further Assistance:

Exar Corporation Headquarters and Sales Offices

48720 Kato Road Tel.: +1 (510) 668-7000
 Fremont, CA 94538 - USA Fax: +1 (510) 668-7001
 www.exar.com

NOTICE

EXAR Corporation reserves the right to make changes to the products contained in this publication in order to improve design, performance or reliability. EXAR Corporation assumes no responsibility for the use of any circuits described herein, conveys no license under any patent or other right, and makes no representation that the circuits are free of patent infringement. Charts and schedules contained here in are only for illustration purposes and may vary depending upon a user's specific application. While the information in this publication has been carefully checked; no responsibility, however, is assumed for inaccuracies.

EXAR Corporation does not recommend the use of any of its products in life support applications where the failure or malfunction of the product can reasonably be expected to cause failure of the life support system or to significantly affect its safety or effectiveness. Products are not authorized for use in such applications unless EXAR Corporation receives, in writing, assurances to its satisfaction that: (a) the risk of injury or damage has been minimized; (b) the user assumes all such risks; (c) potential liability of EXAR Corporation is adequately protected under the circumstances.

Reproduction, in part or whole, without the prior written consent of EXAR Corporation is prohibited.



A New Direction in Mixed-Signal